

# VISIONART®

NUMARALI SPORCU GÖZLÜKLERİ

# Rx

**jsbir** Optik



**RUDY PROJECT**  
Technically Cool



# İçindekiler

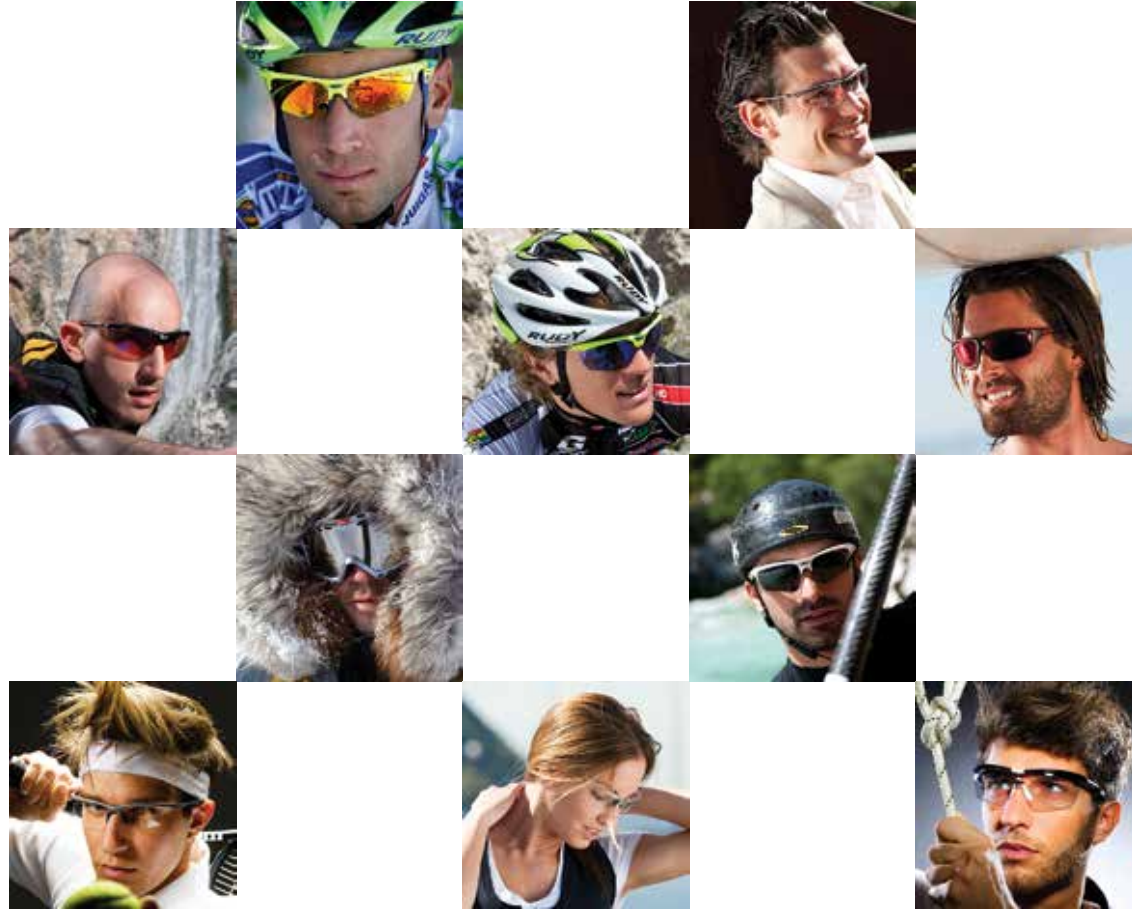

Magster	32
Genetyk	33
Noyz	34
Rydon	35
Guardyan	36
Gozen	37
Klonyx Snow	38
Maya	39
Maya Flip-Up	44

# MAGSTER



 Kahverengi  
SN 66 46 29 E

Ağırlık: 29gr Ekartman A: 71 B: 41 DBL: 14  137 Baz: 8

- İç kısma yerleşen insert ile, RX cam yapılabılme özelliği
- Darbe ve kırılmalara karşı dirençli
- Kolay ayarlanabilir esnek burunluk ve saplar.
- Buğulanmayı azaltan özel tasarım
- Antialerjik malzeme
- Üstün tutuş sağlayan lastik bant
- Hafif



 Mat Siyah  
SN 66 01 06



 Mat Siyah  
SN 66 10 06 E



İnsert FR 70 00 00

# GENETYK

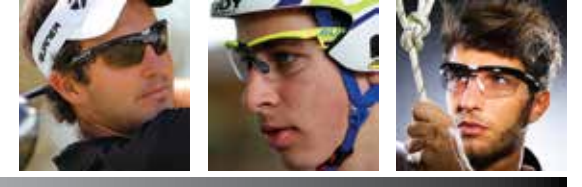

Füme Sarı  
SP 11 09 87

Ağırlık: 33gr Ekartman A: 137 B: 46 DBL: 14 133 Baz: 6

- İç kısma yerleşen insert ile, RX cam yapılabilmeye özelliği
- Darbe ve kırılmalara karşı dirençli
- Kolay ayarlanabilir esnek burunluk ve saplar
- Buğulanmayı azaltan özel tasarım
- Antialerjik malzeme
- Üstün tutuş sağlayan lastik bant
- Hafif



Beyaz Kırmızı  
SP 11 84 69 RC



Mat Siyah  
SP 11 10 06



İnsert FR 05 00 00

# NOYZ



Mat Siyah  
SP 04 01 06

Ağırlık: 33gr Ekartman A: 67 B: 41 DBL: 16 126 Baz: 8

- İç kısma yerleşen insert ile, RX cam yapılabilme özelliği
- Darbe ve kırılmalara karşı dirençli
- Kolay ayarlanabilir esnek burunluk ve saplar.
- Buğulanmayı azaltan özel tasarım
- Antialerjik malzeme
- Üstün tutuş sağlayan lastik bant
- Hafif



Insert FR 70 00 00



Mat Siyah  
SP 06 39 69



Mat Siyah  
SP 04 38 69



Mat Siyah  
SP 04 09 06

# RYDON



 Gri Turuncu  
SN 79 40 98 M

Ağırlık: 24gr Ekartman A: 68 B: 38 DBL: 17  138 Baz: 8

- İç kısma yerleşen insert ile, RX cam yapılabilmeye özelliği
- Darbe ve kırılmalara karşı dirençli
- Kolay ayarlanabilir esnek burunluk ve saplar.
- Buğulanmayı azaltan özel tasarım
- Antialerjik malzeme
- Üstün tutuş sağlayan lastik bant
- Hafif



Insert FR 70 00 00



 Gümüş Mavi  
SN 79 39 11 M



 Mat Siyah  
SN 79 98 06



 Mat Siyah  
SN 79 07 11

# GUARDYAN



İnci Beyaz  
SN 16 86 24

Ağırlık: 29gr Ekartman A: 62 B: 38 DBL: 16 127 Baz: 8

- İç kısma yerleşen insert ile, RX cam yapılabilme özelliği
- Darbe ve kırılmalara karşı dirençli
- Kolay ayarlanabilir esnek burunluk ve saplar.
- Buğulanmayı azaltan özel tasarım
- Antialerjik malzeme
- Üstün tutuş sağlayan lastik bant
- Hafif



Mat Siyah  
SN 16 81 06



Özel süngerli platform ve lastik bant



Insert FR 70 00 00



# GOZEN



inci Beyaz  
SP 15 38 69 MR



Mat Siyah  
SN 15 10 06

Ağırlık: 30,8gr Ekartman A: 65 B: 37 DBL: 15 123 Baz: 8



Insert FR 70 00 00

- İç kısma yerleşen insert ile, RX cam yapılabilme özelliği
- Darbe ve kırılmalara karşı dirençli
- Kolay ayarlanabilir esnek burunluk ve saplar.
- Buğulanmayı azaltan özel tasarım
- Antialerjik malzeme
- Üstün tutuş sağlayan lastik bant
- Hafif

# KLONYX SNOW



Titanyum  
MK 12 21 58

Ağırlık: 128gr

- İç kısma yerleşen insert ile, RX cam yapılabilme özelliği
- Darbe ve kırılmalara karşı dirençli
- Kolay ayarlanabilir esnek burunluk ve saplar.
- Buğulanmayı azaltan özel tasarım
- Antialerjik malzeme
- Üstün tutuş sağlayan lastik bant
- Hafif



Burunluk  
AC 56 00 07 R



Aparatlı Insert AC 56 00 20  
\*Özel montaj aparatı ile

# MAYA



Ağırlık: 128gr



- 10 farklı cam şekli ve 15 farklı çerçeve ile, 150 modele kadar gözlük tasarlanabilir.
- Darbeye dayanıklı RX cam seçeneğiyle tüm gözlük kullanıcılarına, özellikle spor aktivitelerinde özgürlük verir.
- Esnek hammadde sayesinde, darbeye karşı dayanıklıdır. Bu özelliğiyle, çerçeveler kırılmaya karşı dirençlidir.
- Modayı takip eden sporcular için rahatlığı kadar görselliğiyle de ideal gözlüklerdir.
- 360°ye kadar esnek olan çerçeve saplar tutunma ve kavramayı artırır.
- Antialerjik
- Çerçevelerin saplarına takılan lastik bant, yüzü kavrayarak, çerçevenin düşme ihtimalini azaltır.
- Hafif

# MAYA

## Montaj Detayları:

Nilör kanalı için önerilen ölçüler:

- Derinlik 0.8 mm
- Kalınlık 0.8 mm
- Kenar kalınlık 2.8 mm

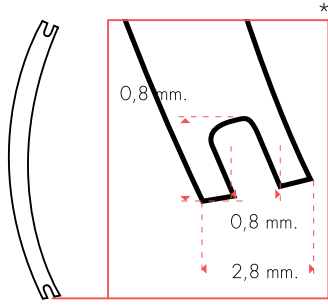

Maya çerçevelerine her türlü hammadde ve şekilden cam monte edilebilir\*.  
Ancak önerilerimiz şunlardır:

- Trivex
- Yüksek indeksli camlar (1.60 - 1.67)
- Polikarbonat

\*Multifokal camlarda cam özellikleri ve progressive koridoru gibi farklılıklar dikkate alınarak kullanıcı ihtiyaçlarına göre montaj yapılmalıdır.

## Klipali cam nasıl çıkartılır?

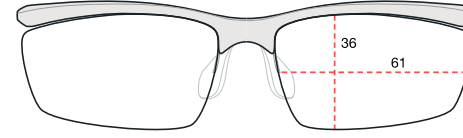
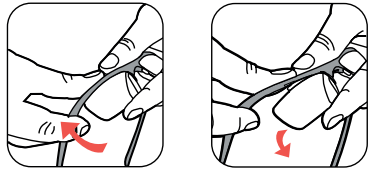

Şekil H 61 | 36 mm

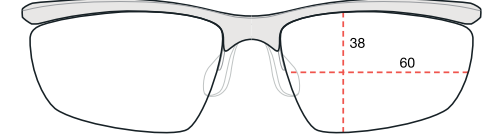

Şekil I 60 | 38 mm

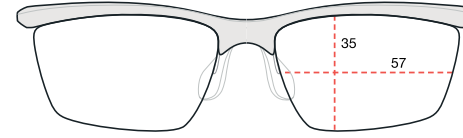

Şekil B 57 | 35 mm

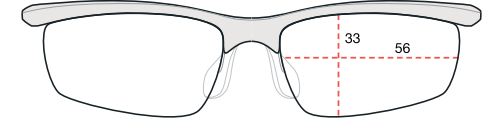

Şekil F 56 | 33 mm



Şekil G 56 | 28 mm

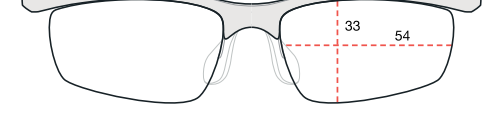

Şekil C 54 | 33 mm



Şekil D 54 | 30 mm



Şekil S 53 | 34 mm



Şekil A 53 | 29 mm

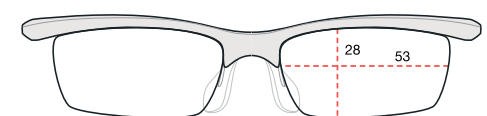

Şekil E 53 | 28 mm

## Şekil H

FR180002H  
61 / 36 mm



## Şekil B

FR180002B  
57 / 35 mm



## Şekil G

FR180002G  
56 / 28 mm



## Şekil D

FR180002D  
54 / 30 mm



## Şekil A

FR180002A  
53 / 29 mm



## Şekil I

FR180002I  
60 / 38 mm



## Şekil F

FR180002F  
56 / 33 mm



## Şekil C

FR180002C  
54 / 33 mm



## Şekil S

FR180002S  
53 / 34 mm



## Şekil E

FR180002E  
53 / 28 mm



# MAYA



Çerçeve 1 Kristal Siyah



Çerçeve 3 FÜme Beyaz



Çerçeve 4 FÜme Siyah



Çerçeve 5 FÜme Turuncu

# MAYA

## tüm renkler



Çerçeve 6 Buzlu Beyaz Siyah



Çerçeve 10 Gri Beyaz



Çerçeve 14 Turuncu Beyaz



Çerçeve 7 Buzlu Beyaz Kırmızı



Çerçeve 11 Gri Siyah



Çerçeve 15 Mavi Beyaz



Çerçeve 9 Gri Kırmızı



Çerçeve 12 Kristal Kahve



Çerçeve 16 Parlak Siyah

10 farklı cam şekli  
15 farklı çerçeve şekli  
150 kombinasyon



Çerçeve 13 Pembe Beyaz



Çerçeve 17 Parlak Beyaz

# MAYA FLIP-UP



Siyah Aynalı Flip-Up Camı  
LE 12 38 03



Kırmızı Aynalı Flip-Up Camı  
LE 12 09 03

Ağırlık: 35gr Ekartman A: 53 B: 34 DBL: 20 137 Baz: 6

- Siyah ve kırmızı renk flip-up aparatı ile Maya güneş gözlüğü olarak ta kullanılabilir.
- Araç sürüşlerinde kolay kullanılabilir.
- Ani ışık koşulları değişimi için idealdir.



Siyah Flip-Up



Kırmızı Flip-Up



Siyah Flip-Up Aparatı  
FR 12 88 98



Kristal Flip-Up Aparatı  
FR 12 88 91





**jsbir** Optik

[www.isbiroptik.com](http://www.isbiroptik.com)